

## PA168X SIP Phone Menu Guide

➤ <i>Function Keys Introduction:</i> .....	2
➤ <i>Operate with the keys</i> .....	2
➤ <i>Set the main menu</i> .....	3
➤ <i>Set the network submenu</i> .....	4
➤ <i>Set the audio submenu</i> .....	4
➤ <i>Set the dial plan submenu</i> .....	5
➤ <i>Set the protocol menu</i> .....	5
➤ <i>Set the other menu</i> .....	6
➤ <i>Set the Advanced menu</i> .....	6

When PA168X SIP phone has been installed properly, you can enter the menu through the keyboard and LCD, and then set each parameters accordingly.

## ➤ **Function Keys Introduction:**

When using keyboard and LCD to configure the settings of IP phone, following keys will be employed:

<b>Keys</b>	<b>Function</b>	<b>Keys</b>	<b>Function</b>
<b>Menu/Enter</b>	Enter the menu and confirm.	<b>Set</b>	Becomes to modify the appearance.
<b>Backspace</b>	Delete and back upper menu.	<b>Vol+</b>	Turn over menu backward.
<b>Keypads</b>	Modify values	<b>Vol -</b>	Turn over menu forward.

## ➤ **Operate with the keys**

- **Enter the menu mode**

Press “Menu/ Enter” key, and then use the keyboard to enter the password of the phone (when debug is not set as 0[disable], default password is 1234; when debug is set as 0[disable], please use super password 12345678), Secondly, Press “Menu/ Enter” key to confirm, PA168X IP phone will enter the menu mode.

- **Select the submenu**

After entering the main menu, press “VOL+” or “VOL-” to page the menu up or page the menu down; when you want to set the submenu item to be displayed, press “Menu/ Enter” to enter the submenu.

- **Enter the EDIT mode**

After entering the submenu, when you want to set the submenu item to be selected, press “Set” to enter EDIT mode.

- **Enter the settings**

Once the phone enters EDIT mode, enter the settings by numeric keypad respectively, then press “Menu/ Enter” key to confirm.

- **Modify enter error**

If the errors come forth when you enter the settings, press “Backspace” key to delete it and enter the settings again

- **Abort the settings**

If there is no need for the modified settings, press “Backspace” key to return to the main menu, and press “VOL+” or “VOL-” to page the menu up or page the menu down; When “exit settings” submenu item is selected, press “Menu/ Enter” key to confirm, PA168X IP phone will reboot and be used the current settings.

- **Save the settings**

When all parameters have modified, press “Backspace” key to return to the main menu, and press “VOL+” or “VOL-” to page the menu up or page the menu down; When “save settings” submenu item is selected, press “Menu/ Enter” key to confirm, PA168X IP phone will reboot and use the already modified setting.

➤ **Set the main menu**

- **Main Menu Structure**

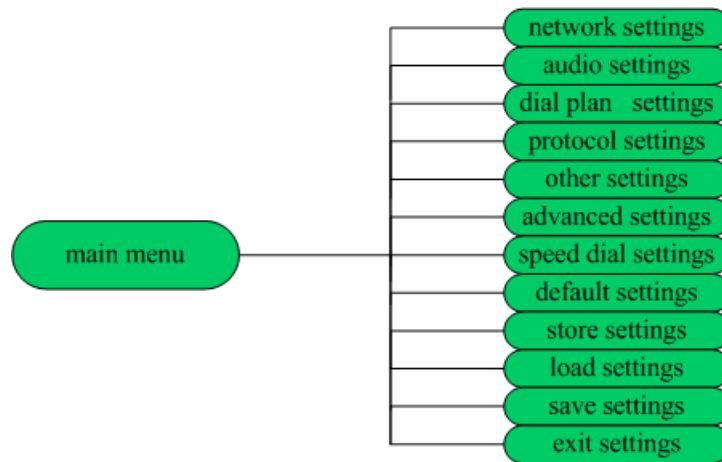

Fig 1.1 Main Menu structure Illustration

➤ **Set the network submenu**

● **Network Submenu Structure**

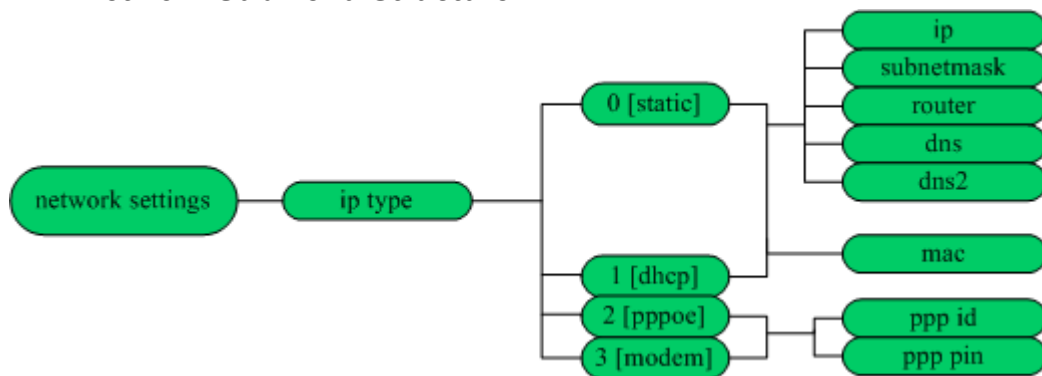

Fig 1.2 Network submenu structure Illustration

➤ **Set the audio submenu**

● **Audio Submenu Structure**

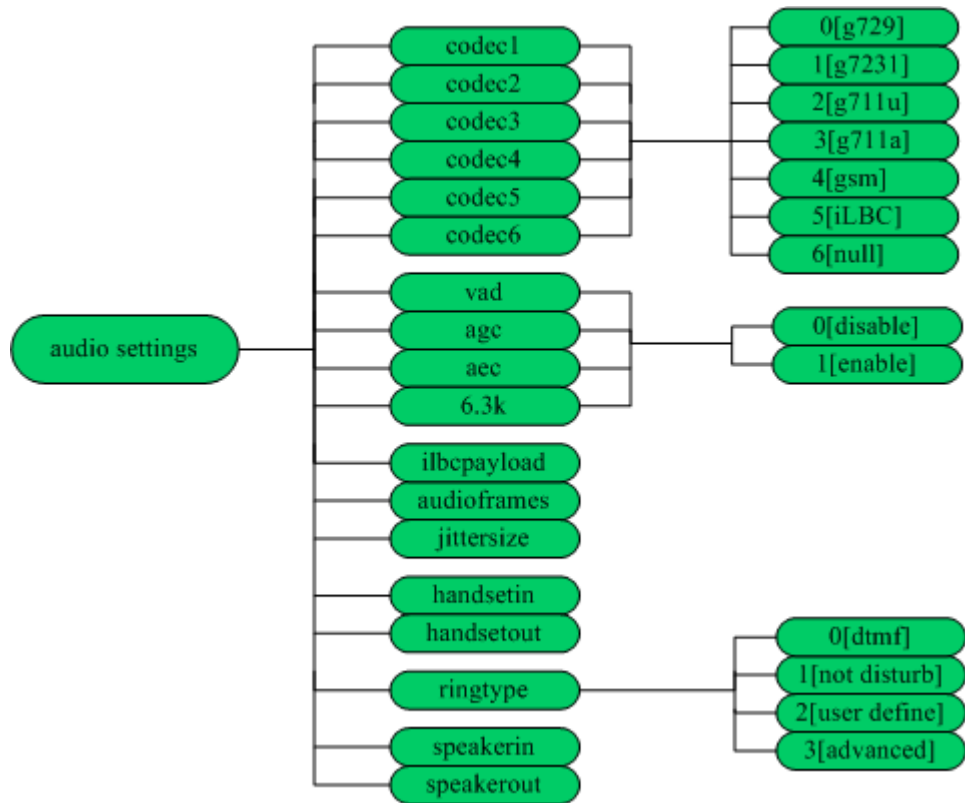

Fig 1.3 Audio submenu structure Illustration

➤ **Set the dial plan submenu**

● **Dial plan submenu Structure**

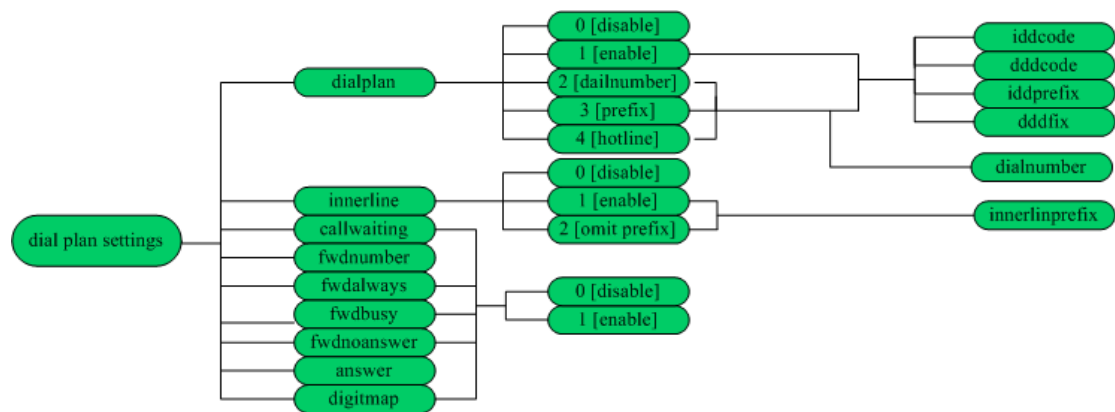

Fig 1.4 Dial plan submenu structure Illustration

➤ **Set the protocol menu**

● **Protocol Submenu Structure**

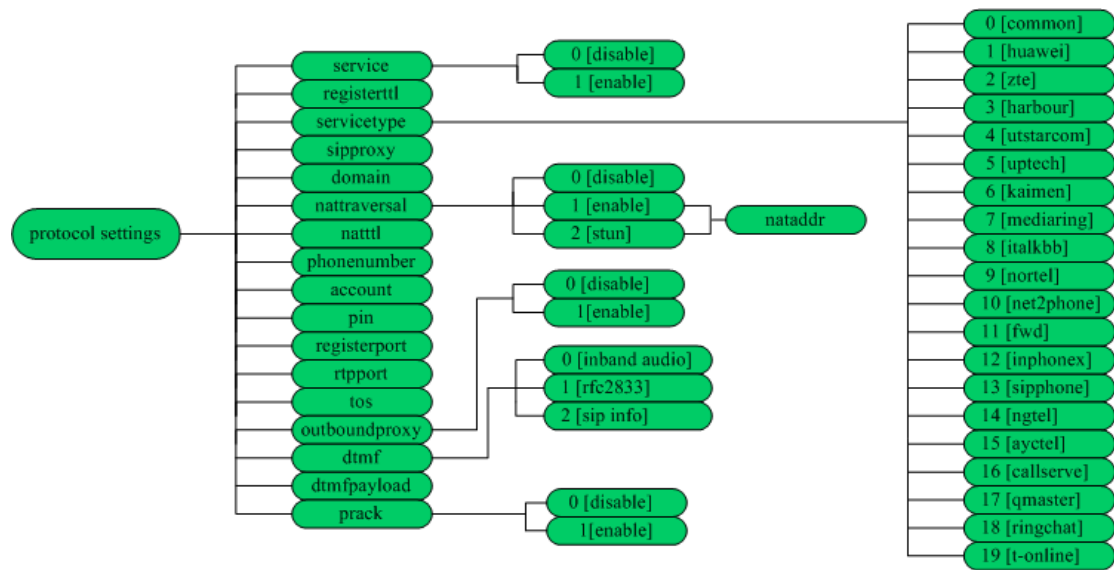

Fig 1.5 Protocol submenu structure Illustration

➤ **Set the other menu**

● **Other Submenu Structure**

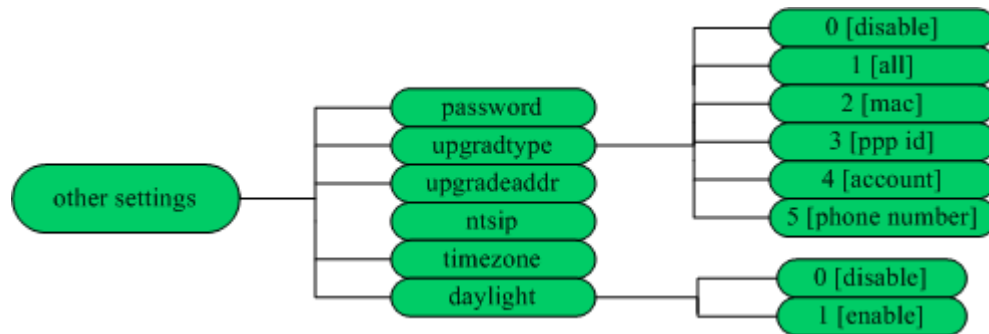

Fig 1.6 other submenu structure Illustration

➤ **Set the Advanced menu**

● **Advanced Submenu Structure**

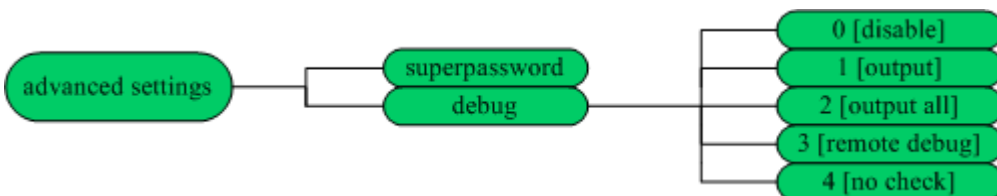

Fig 1.7 advanced submenu structure Illustration

**Appendix Table:** PA168X IP phone digital-character key map:

Keys	Press Once	Press Twice	Press Thrice	Press quartic	Press quintic
<b>1</b>	1	.	,	?/_	!//
<b>2</b>	2	A/a	B/b	C/c	[
<b>3</b>	3	D/d	E/e	F/f	]
<b>4</b>	4	G/g	H/h	I/i	*
<b>5</b>	5	J/j	K/k	L/l	
<b>6</b>	6	M/m	N/n	O/o	#
<b>7</b>	7	P/p	Q/q	R/r	S/s
<b>8</b>	8	T/t	U/u	V/v	
<b>9</b>	9	W/w	X/x	Y/y	Z/z
<b>*</b>	.				
<b>0</b>	0	space	:/@	;/-	\/&
<b>#</b>	Case change				

*Reserves the right to make changes in technical and product specification  
without prior notice.*